

Fan Temperature Detection Using Microcontroller

Cindi Rori
Informatics Engineering
Univ. De La Salle Manado
cindyrondonuwu@gmail.com

Rinaldi Munir
Informatics Engineering
Institut Teknologi Bandung
rinaldi@informatika.org

Debby Paseru
Informatics Engineering
Univ. De La Salle Manado
dpaseru@unikadelasalle.ac.id

Pinrolinvic Manembu
Informatics Engineering
Univ. Sam Ratulangi
pmanembu@gmail.com

Abstract — Current fan is not able to display room temperature and humidity. It also cannot run automatically on a specified time or room temperature. Therefore it should consider a system that can overcome these weaknesses. This research will make a room temperature control system that can detect temperature and humidity, and displays the results to the application. Systems made useful to control the fan so that the room temperature is still cool. The system will interact with the user through the application, both for switching on and off the fan directly or automatically based on temperature and time. This research uses the C# programming language in the creation of applications and C for coding of microcontroller. The methodology used is prototyping. Testing conducted concluded that the application can display the values of temperature and humidity, a function to turn on and turn off the fan directly or based on temperature and time can run well.

Keywords: *fan, detection, microcontroller, temperature.*

I. BACKGROUND

Humans need cool air in order to move comfortably. Many electronic devices are made to maintain the room temperature stays cool. The fan is one of the air conditioners that were encountered but the current fan is not able to display the room temperature and humidity. The fan also cannot adjust automatically with the room temperature or time. In addition, the fan is executed by pressing the on-off, by hand. To overcome the above drawbacks and to support the performance and automation on the fan requires a microcontroller and a program to control it. The microcontroller is an integrated chip that typically becomes part of an embedded system designed to perform one or more specific functions in real time. Microcontroller shape is very small and simple and includes all the necessary functions on a single chip.

Based on the description above, this research will create an application that can control the fan (*on-off*) based on the room temperature and time automatically using microcontroller so that the room temperature is still cool.

II. LITERATURE REVIEW

A. Detection

The detection is a process of identifying a problem if there is a failure in the prevention and notify the executor [1]. The detection tool is a tool used by user to help identify a problem.

The process of identifying the problem starts from the existence of a problem that appears (where there is a state which is not in accordance with the state in general) was realized and find a way out, either by step overall settlement or quite simply reached the point of prevention.

B. Microcontroller

Immersa [3] stated that the microcontroller consists of CPU, Memory, I / O ports and timers like a standard computer, but is designed only to carry out a specific function in regulating the system.

There are many microcontrollers in stores however microcontroller used in this research is microcontroller DHT22 as a temperature sensor. The microcontroller set on Arduino board. The main component in the board Arduino used is a microcontroller 8 bit with brands ATmega made by the company Atmel Corporation. A simplified block diagram exist in ATmega328 microcontroller used in Arduino Uno (*unoDFRduino*) can be seen in Figure 1.

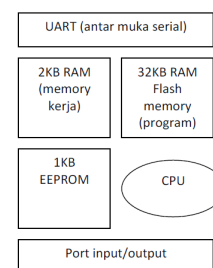

Figure 1. Block diagram of *microcontroller ATmega328* [2]

This research is used a microcontroller DHT22 [6] because it has several advantages over another temperature sensor.

C. Temperature Sensor

The temperature sensor is a component that is normally used to convert heat into electricity to ease the analysis magnitude [4]. The temperature sensor is made using a metal or a semiconductor material. This method is used because the metal or semiconductor material can change its resistance to electrical currents depending on temperature.

D. Data Communication

Data communication is necessary for exchanging data between sender and receiver in this study. This data communication is needed to give commands from the application to the Arduino to turn on and turn off the fan through relay, and to send the value of the temperature and humidity of the sensor to the application via the Arduino.

E. Related Research

There are several studies related to this research, which are the Temperature Gauge System Design Using Arduino and C # .Net by Lucky Yuditia Putra and the Design and Implementation of Control Room Temperature Using Microcontroller-Based Sensor LM35 Arduino Uno by Fadilla Zennif.

Putra [5] used LM35 sensor to determine the temperature of the room easily and use .Net C # as the programming language. The system made can measure the temperature of the room with a tolerance value of data is not stored in one minute. When the temperature exceeds the set temperature, the fan will rotate automatically as an air conditioner. The system works every second and displays the result on desktop application and saves it to the database as a repository.

While Zennifa [7] made the room temperature controller based on input from the keypad. This tool uses the temperature sensor with the code LM35 and type LM35DZ, which has its advantages and conveniences that range of temperatures measurability quite wide, has a high accuracy, the economic cost and also use Arduino. The system also use LCD as a display and *keypad* as one of the factors that made the temperature can be controlled. The magnitude of the temperature is read will be displayed on the LCD and then the output will be shown on rotation of the fan.

III. ANALYSIS

A. Preliminary Analysis

Based on analyzing the previous researches and the observation made, this research generating some specifications of the requirements needed. This research will build a system that can control a

fan using DHT22 as microcontroller and create an application to control the system.

As for the specifications of the application made is:

1. Application can detect the room temperature and humidity.
2. Application can transmit temperature values from sensor DHT22 to the microcontroller.
3. Application can display temperature values that exist on the microcontroller in the application.
4. Application can turn off and turn on the fan based on room temperature and time.
5. Application can turn off and turn on the fan without the value of the room temperature or time.

B. User Analysis

Table 1. User Analysis

No.	User	Task
1.	Human	Use and control the application and system.

C. Data and Communication Analysis

This section will discuss the communication between users, systems and applications created as follows:

Users used the system access the existing applications on the computer but before that, the user must choose the *ports* used by the microcontroller. If the *ports* are correct, the application will display the room temperature data were taken from the temperature sensor DHT22 through the microcontroller.

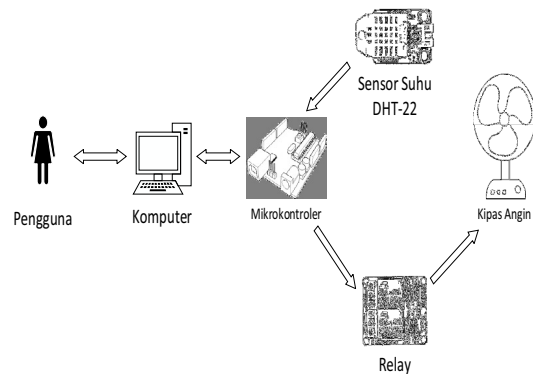

Figure 2. Overview of System Performance

D. Flowchart

Figure 3 described the process of application and detection system made as follows:

To get started, a user is required to access an application then the user selects the ports that are connected to the microcontroller. If the user choose the right ports, then the application will display the temperature and humidity in the room, as well as time. For setting, if a user fills temperature limit, then the application will store it into a variable InputSuhu later then do timer settings. If the user

set the timer, then the application will save to a variable timer then activate the system. When the user activates the system by pressing an on button on the application, the system will run in accordance with the temperature and timer settings that have been done in the previous stage. If the temperature is not filled and the timer is not set by the user, then the system will automatically run the fan. By the time the user wants to turn off the system, then the user simply presses the off button available on the application, if not then the system will run continuously in accordance with the arrangements that have been made.

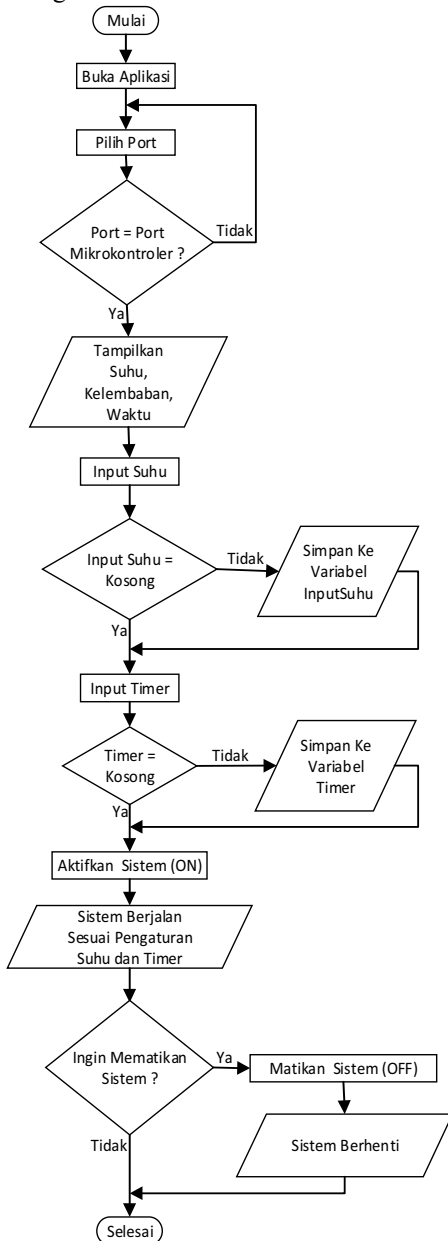

Figure 3. Application and Detection System Flowchart

IV. DESIGN AND IMPLEMENTATION

After conducting the analysis, the design of detection systems and applications is:

A. Interface Design

After doing analysis, the creation of application is made. Figure 4 shows the application interface. The design shows when a user has selected ports a microcontroller connected and has hit the refresh button, the user can fill in the normal temperature textbox as the room temperature limit. It aims to be switched on when the fan is above the normal temperature and will shut down if it is at normal temperature or below. Users can choose the time to turn on and turn off the fan. Besides that, the application will display the indoor temperature and humidity changed every second.

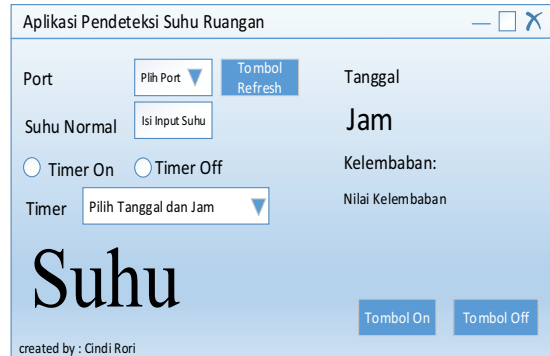

Figure 4. Interface Design

B. Database Design

To keep the temperature and humidity values required a design database that described in this following *Class Diagram*:

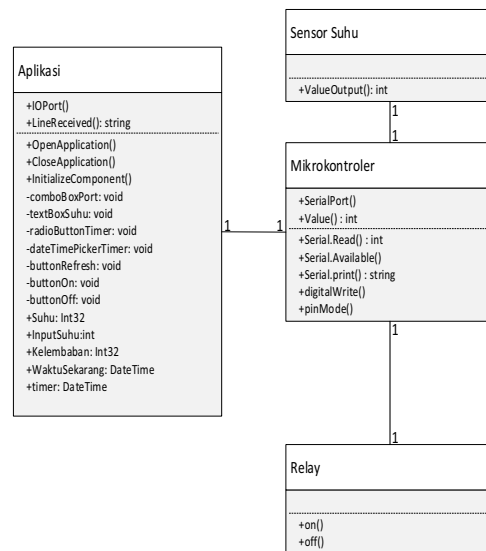

Figure 5. Class Diagram

C. Hardware Design

Applications will be connected to the microcontroller via USB so that the user can interact. As seen in Figure 6, pin 5v and gnd useful as a power of the microcontroller to the breadboard, henceforth connected to temperature sensors and relays. Pin 2 microcontroller connected to the relay will give the command on or off, while pin 3 microcontroller connected to

the temperature sensor will accept the values of temperature and humidity. Fan cable consists of two small wires. 1 cable is cut to go first to relay to then be connected to a power source. It is intended that the process of turning on and off the fan can be controlled by the relay.

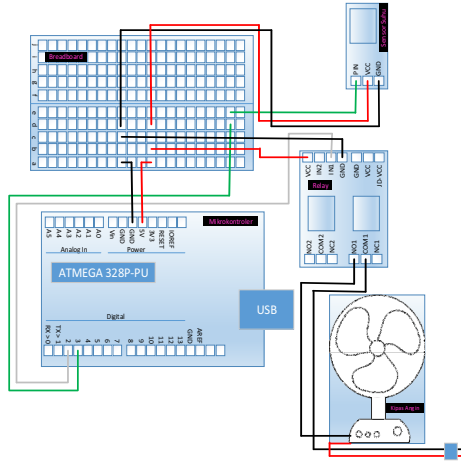

Figure 6. Hardware

The existing hardware circuit further implemented using various tools as follows: In the figure 7, all the components are inside the box. Sensor facing out of the box in order to test the air temperature easily. Fans used as a booster tool is a laptop cooling fans. Connections between components using jumper cables through breadboard. Using breadboard facilitate cables jumper can be connected without the need for soldered and easily moved. USB cable from the microcontroller is made out of the same box with a USB fan cable connected to the relay so it is easy to connect to the computer.



Figure 7. Control System Room Temperature

V. TESTING AND RESULTS

A. Application Testing

After the application and hardware are connected, the system will be test if it is running well or not.

The purpose of the application testing is done as follows:

1. To check whether the system is made to detect the temperature of the room.

2. To test whether the system can send the temperature value from the sensor to the microcontroller DHT22
3. To determine whether the system can display temperature values that exist on the microcontroller in application.
4. To ascertain whether the fan can function based on the temperature of the room.
5. To ascertain whether the fan can function based on the specified time.
6. To ascertain whether the fan can function without the value of the room temperature or time.
7. To test whether the function of the system can only be accessed through an application.

B. Criteria of Testing

The criteria of testing for this application is:

1. Application can be run when a right port is chosen.
2. All the functions of the application is running properly.
3. Controlling the fan runs fine on AC or DC current.

C. Testing Case

Here are some testing cases and their result:

Table 2. Communication and Relay Test

No.	Activity	Result
1.	Choose the ports	All ports are on
2.	Press the refresh button	Value of temperature and humidity will be displayed
3.	Command turn on	Fan on
4.	Command turn off	Fan off

Table 3. Time and Temperature Test

No.	Activity	Result
1.	Command turn on after temperature	Fan on and off based of temperature setting

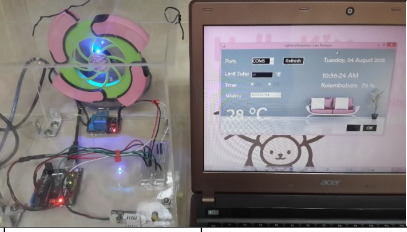
No.	Activity	Result
	<i>setting</i>	
		
3.	<i>Command turn on after on time setting</i>	<i>Fan on based of time setting</i>
4.	<i>Command turn on after off time setting</i>	<i>Fan off based of time setting</i>

- Putra, L. Y. (2013). Perancangan Sistem Pengukur Suhu Menggunakan Arduino dan C#.Net. Jakarta: Universitas Mercu Buana.
- Vcc2gnd. (2014). DHT22. [ONLINE] Available at : <http://vcc2gnd.com/sku/DHT22>. [Diakses 5 Maret 2015].
- Zennifa, F. (2012). Perancangan dan Implementasi Pengontrol Suhu Ruang dengan Menggunakan Sensor LM35 Berbasis Mikrokontroler Arduino Uno. Univesitas Andalas. Padang.

VI. CONCLUSIONS AND RECOMMENDATIONS

A. Conclusions

- The system can switch on and off the fan automatically based on the room temperature and time setting.
- The system can display the temperature and humidity directly.
- The detection system and application are run well.

B. Recommendations

As for suggestions for the development of the system is:

- The use of other tools that can control the fan without using applications on the computer.
- Adding a tool to control the rotary speed of the fan.
- Making the system design more efficiently and ergonomic

REFERENCES

- Disky (2015). Pengertian Deteksi. [ONLINE] Available at : http://news.palcomtech.com/wp-content/uploads/2012/01/Jurnal_Disky_ImplementasiHonepot.pdf. [Diakses 5 Agustus 2015]
- Djuandi, F. (2011). Pengenalan Arduino. [ONLINE] Available ats : www.tobuku.com/docs/Arduino-Pengenalan.pdf. [Diakses 28 Februari 2015].
- Immersa. (2014). Pengenalan Mikrokontroler. [ONLINE] Available at : <http://www.immersa-lab.com/pengenalan-mikrokontroler.htm>. [Diakses 29 Februari 2015]
- Komponenelektronika. (2014). Sensor Suhu. [ONLINE] Available at : <http://komponenelektronika.biz/sensor-suhu.html>. [Diakses 5 Maret 2015].